











NIXEA 2
Avec prolongateur de câble
PHOENIX « QUICKON »
Pour l'antenne









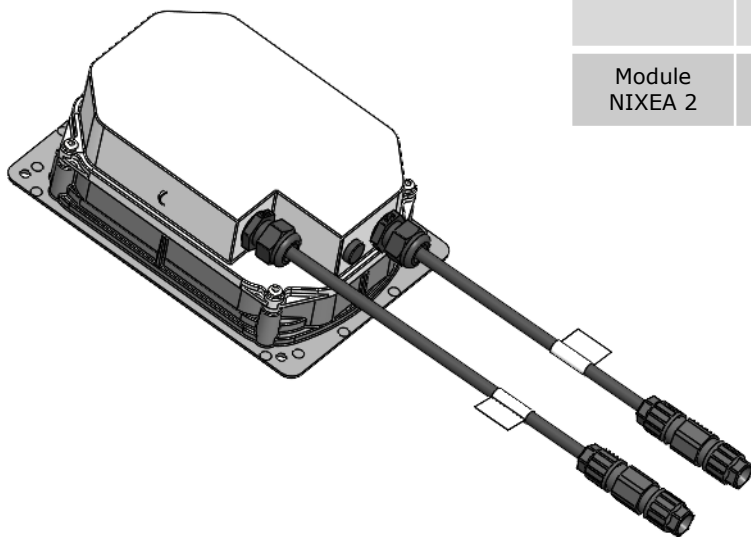





220-240V 50Hz

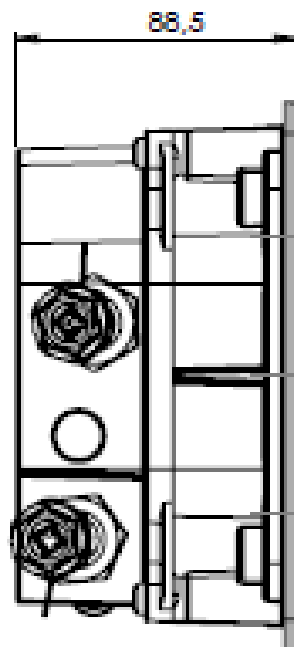
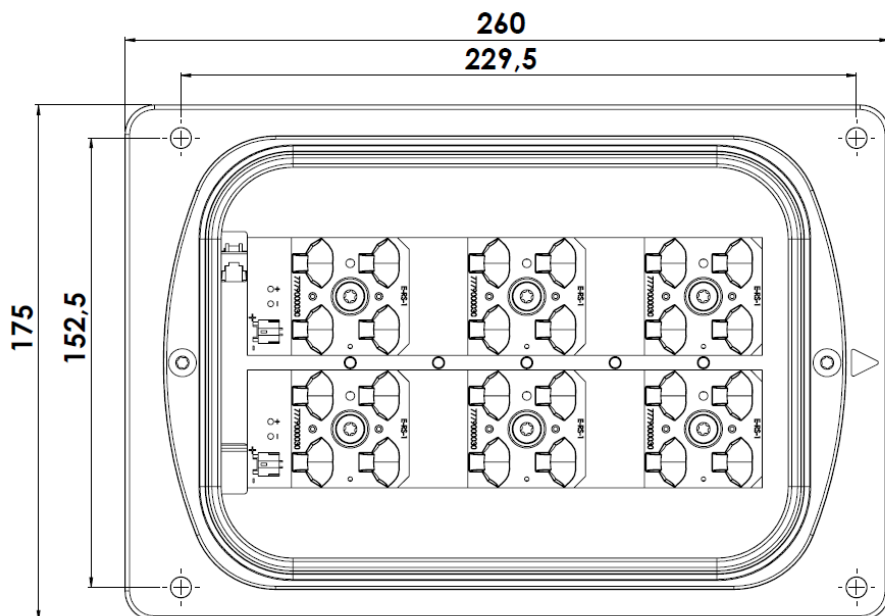

	IK	 kg	SCx	H max
Module NIXEA 2	10	3,7 kg	-- m ²	10 m

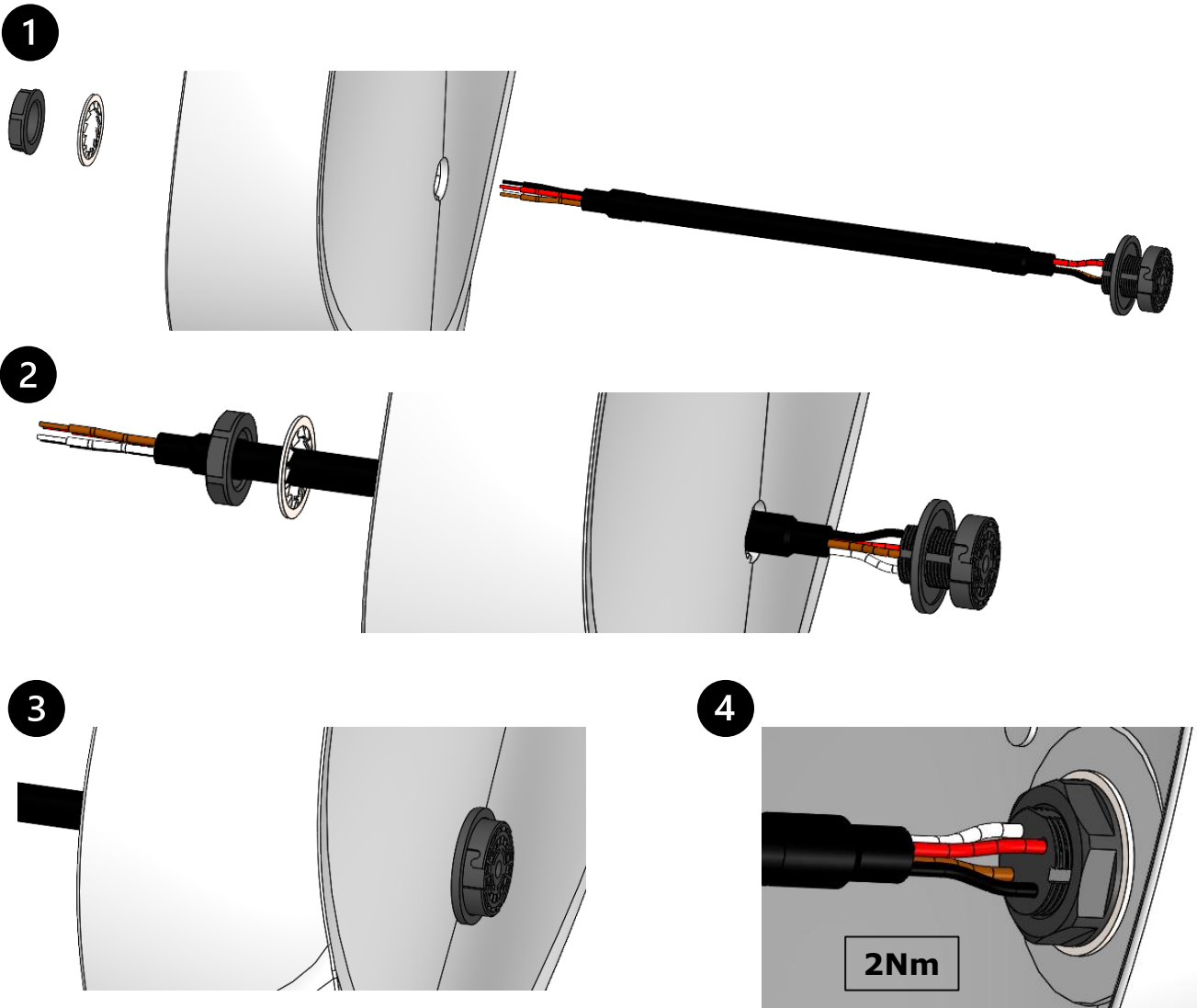



5 Connexion prise ZHAGA

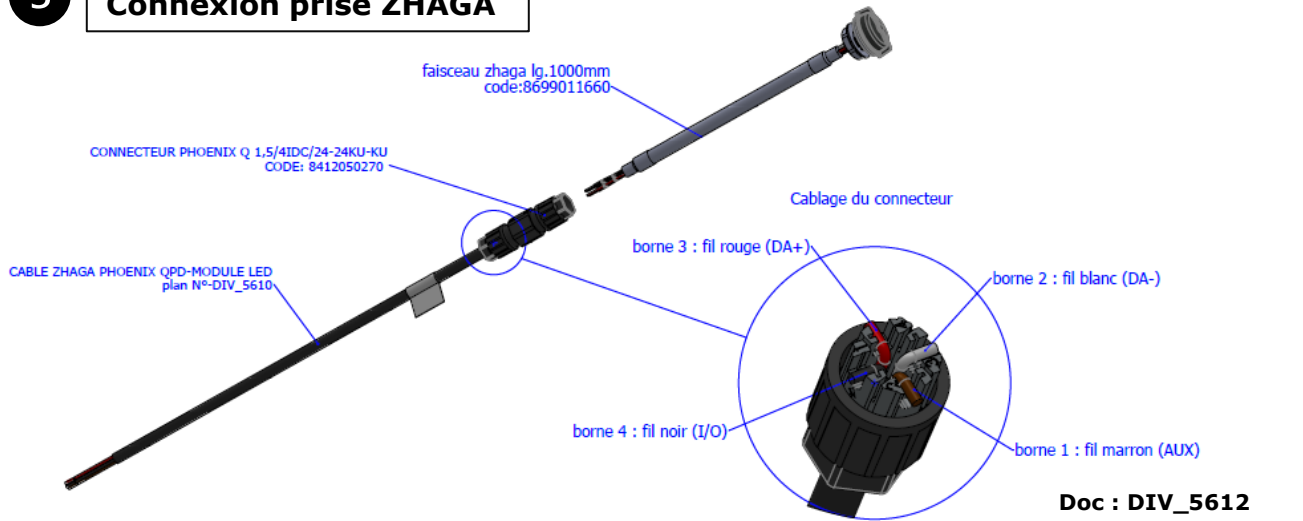

La source lumineuse contenue dans ce luminaire ne doit être remplacée que par le fabricant ou son agent de maintenance ou une personne de qualification équivalente.
 The lighting part included in this luminaire must be maintained by the manufacturer, an authorized service agent or a person with similar technical qualification.
 Die in der Leuchte beinhalten Lichtquelle soll nur durch den Hersteller oder seinen Wartungsfachmann oder einen Servicetechniker mit einer ähnlichen Qualifikation ersetzt werden.

6

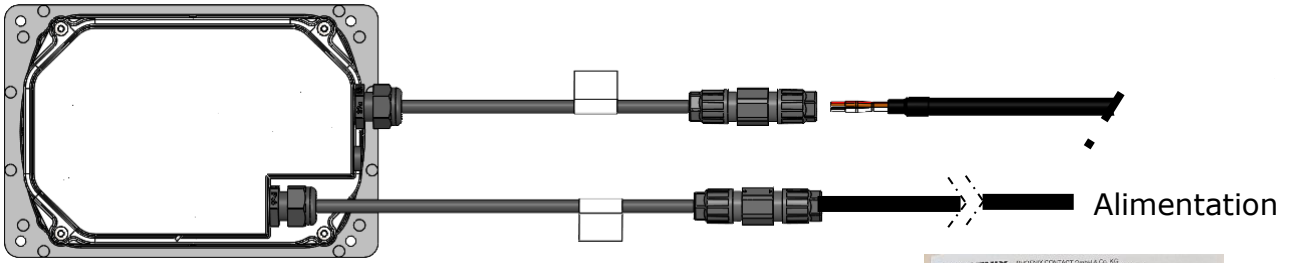

Utiliser la notice du fabricant PHOENIX fournie

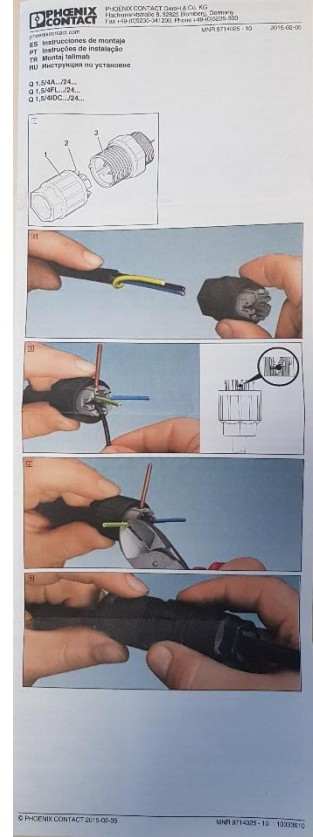

7

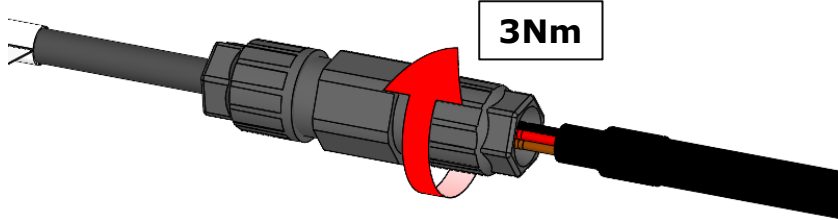

8

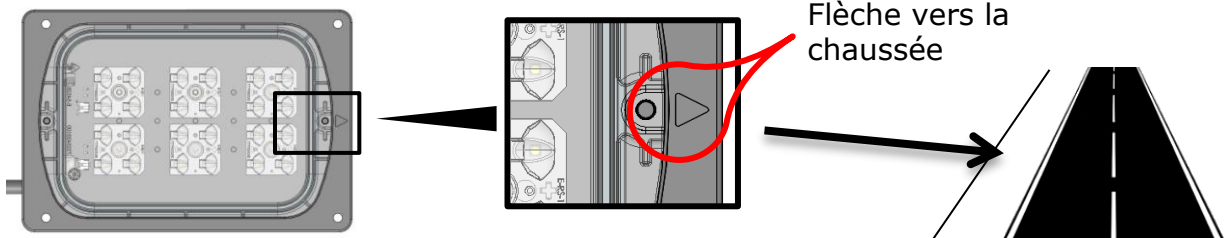

La source lumineuse contenue dans ce luminaire ne doit être remplacée que par le fabricant ou son agent de maintenance ou une personne de qualification équivalente.
 The lighting part included in this luminaire must be maintained by the manufacturer, an authorized service agent or a person with similar technical qualification.
 Die in der Leuchte beinhalten Lichtquelle soll nur durch den Hersteller oder seinen Wartungsfachmann oder einen Servicetechniker mit einer ähnlichen Qualifikation ersetzt werden.